



AT-VLS-102DE

Manual

ATAL B.V.
Ampèrestraat 35-37
NL-1446 TR PURMEREND

Postbus 783
NL-1440 AT PURMEREND

T (+31) 0299 630 610
F (+31) 0299 630 611

E info@atal.nl
I www.atal.nl

Inhoud

Manual.....	1
1. General description	4
2. Regulator mounting and connection.....	5
3. Preparation to operation.....	5
3.1. Procedure of instrument connection	6
4. Dimensions	7
5. Installation	10
5.1. Installation procedure	10
6. Operation checking.....	10
6.1. Visual check	10
6.2. Communication check via a LAN	11
7. Description of device function and setting.....	11
7.1. Relay outputs.....	11
7.2. Carbon dioxide concentration measurement	11
7.3. Actual regulator preset – measurement part.....	12
7.3.1. Value assigned to output relay.....	12
7.3.2. When close output relay	12
7.4. Regulator setting change – part of measurement unit	13
7.4.1. Setting with PC and TSensor software	13
7.4.2. Setting with using regulator keys	14
7.4.3. Extended setting mode	14
7.5. Restore to „Factory default“ – measurement part	18
7.6. Regulator configuration – Ethernet interface	19
7.7. Alarms – Ethernet interface	19
7.7.1. Analogue values	19
7.8. Factory default – Ethernet interface	20
8. Communication protocols	20
8.1. Modbus protocol	20
8.2. SMTP.....	22
8.3. SNMPv1	22
8.4. WWW	23
8.5. SNTP.....	23
8.6. Syslog protocol	23
8.7. SOAP	23
9. What to do when.....	24
10. Error States of the device	25
11. Readings on LCD display	26
12. Preventive maintenance and calibration	26
13. Technical specification.....	26
13.1. Technical parameters	26
13.1.1. Common parameters	26
13.1.2. AT-VLS-104DE - CO ₂ regulator	27
13.1.3. AT-VLS-101DE - CO ₂ regulator	27
13.1.4. AT-VLS-102DE – temperature, relative humidity and CO ₂ regulator	27
13.1.5. AT-VLS-106DE – temperature, relative humidity and CO ₂ regulator	28
13.1.6. Relative humidity and temperature restriction	28
13.1.7. Value computed from measured relative humidity and temperature	29
13.2. Operating conditions	30
13.3. End of operation.....	31
13.4. Technical support and service	31
14. Appendix A.....	31

General safety rules

The following summary is designed to prevent injury hazards or device damage. Operate the instrument in accordance with this manual to prevent electric trauma.

Service should be performed by a qualified person only.

Use a safety ac/dc adapter. Use only an adapter with the power voltage recommended by its manufacturer and which is approved by proper standards. Check that the adapter has undamaged cables and cover.

Connect and disconnect correctly. Do not connect and disconnect cables if the device is under electric voltage.

Do not use the instrument without the cover.

Do not use the instrument, if it does not work correctly. If the instrument seems not to work correctly, have it checked by a qualified service person.

Do not use the instrument in an explosive environment.

Read instruction manual before the first device connection, please.

1. General description

The regulators are designed for online measurement of temperature (°C or °F), relative humidity and carbon dioxide concentration of air. Measured temperature and relative humidity are recomputed to following humidity expression: dew point temperature, absolute humidity, specific humidity, mixing ratio and specific enthalpy.

The regulators are designed to be operated in a chemically non-aggressive environment.

Type	Temperature	Humidity	CO ₂	Computed value
AT-VLS-104DE	-	-	✓	-
AT-VLS-101DE	-	-	✓	-
AT-VLS-102DE	✓	✓	✓	✓
AT-VLS-106DE	✓	✓	✓	✓

The device is equipped with two relay outputs for alarming or controlling of external devices. It is possible to assign any input value to each relay, to set comparing limit, delay, hysteresis and acoustic alarm or change its status by far control with using of Modbus communication protocol. The device is communicating through Ethernet interface. The device is internally separated into two units. The first unit provides measurement and controlling of output relays – there is possible to change these parameters directly through device's keys or TSensor software. The second unit provides all Ethernet services, its configuration is possible through Telnet terminal or TSensor software (this setting is impossible to change through device's keys).

Measured and calculated values are available from Ethernet interface or are displayed on LCD. If there are two values displayed at one LCD line, they are periodically switched between both readings with period of 4 seconds. Display can be switched OFF totally. On the left LCD side there are placed three LEDs for CO₂ zone level indication.

The following formats are supported:

- WWW pages with user-design possibility
- Modbus protocol
- SNMPv1 protocol
- SOAP

The instrument may send a warning message to several defined points if the measured value gets out of adjusted limits. There are the following possible ways to deliver the warning report:

- to send an e-mail to maximum of three e-mail addresses
- to send a SNMP trap to maximum of three IP addresses
- to display an alarm state on the device WWW page
- to send a message to Syslog server

Alarm limits may be set via TSensor software, Modbus, Telnet or a SNMPv1 protocol. The alarm state may be read via the device WWW pages, Modbus or the SNMPv1 protocol.

The value assign to each relay is possible through TSensor software or through device's keys.

If Power over Ethernet is needed, it is necessary to use some PoE Splitter. Tested is e.g. D-Link DWL-P50. Regulator itself does NOT support PoE internally!

Regulator supports Internet protocol version 4 (IPv6 is NOT supported).

2. Regulator mounting and connection

Regulators are designed for wall mounting. Device must be mounted on the plane surface to prevent its deformation. Mounting holes and connection terminals are accessible after demounting of four screws in the corners of the box and removing the lid. There is recommended to use screws with half round head with cross-recessed screw ST 3.9 (DIN 7981). External probe for measuring the concentration of CO₂ unpack and connect to the device.

Lace the lead-in cable with outer diameter of 3 to 6.5 mm through the glands at the case wall and connect them according schematic below. Terminals are self-clamping and can be opened by a suitable screwdriver. For the opening, insert the screwdriver to smaller terminal hole and lever by him. Do not forget to tighten glands and case lid with inserted packing after cables connecting. Insert attached plug into unused cable glands too. Do not connect the regulator under voltage.

It is not recommended to use the device AT-VLS-102DE and external RH+T probe of AT-VLS-106DE regulator for long time under condensation conditions. It could be the cause of water steam condensation inside the sensor's cover into water phase. This liquid phase stays inside sensor's cover and can't escape from the cover easily. It can dramatically increase response time to relative humidity change. If water condensation occurs for longer time it can cause sensor damage. Similar effect can occur under water aerosol conditions.

The communication cable must be placed as far as possible from potential interference sources.

Electrical system (wiring) may be done only by a worker with required qualification by rules in operation.

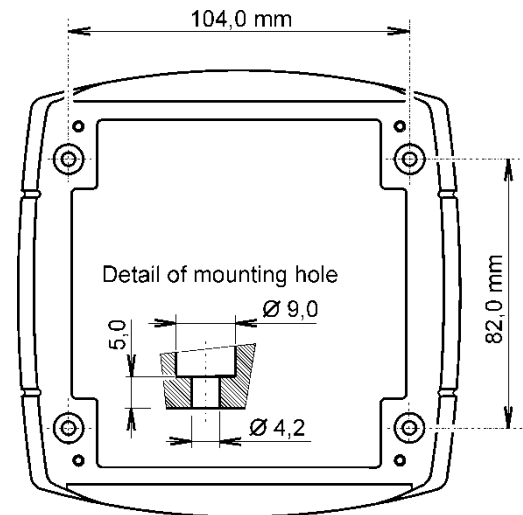

3. Preparation to operation

To provide all Hx5xx regulator functions it is necessary to make its setting through PC to satisfy your requirements. Requested parts necessary for operation:

- ac/dc adapter 9-30V, 200mA or PoE splitter
- RJ-45 LAN connection
- free IP address in your network

Contact network administrator to get free IP address.

Warning! Reliability of warning messages reception (e-mail, trap) depends on current accessibility of required network services. It is recommended to protect device from unauthorized access to device settings and cables connection.

3.1. Procedure of instrument connection

The cables, power adapter or PoE splitter connect in order as shown in the pictures. After power supply connection, make regulator configuration.

AC/DC power adapter

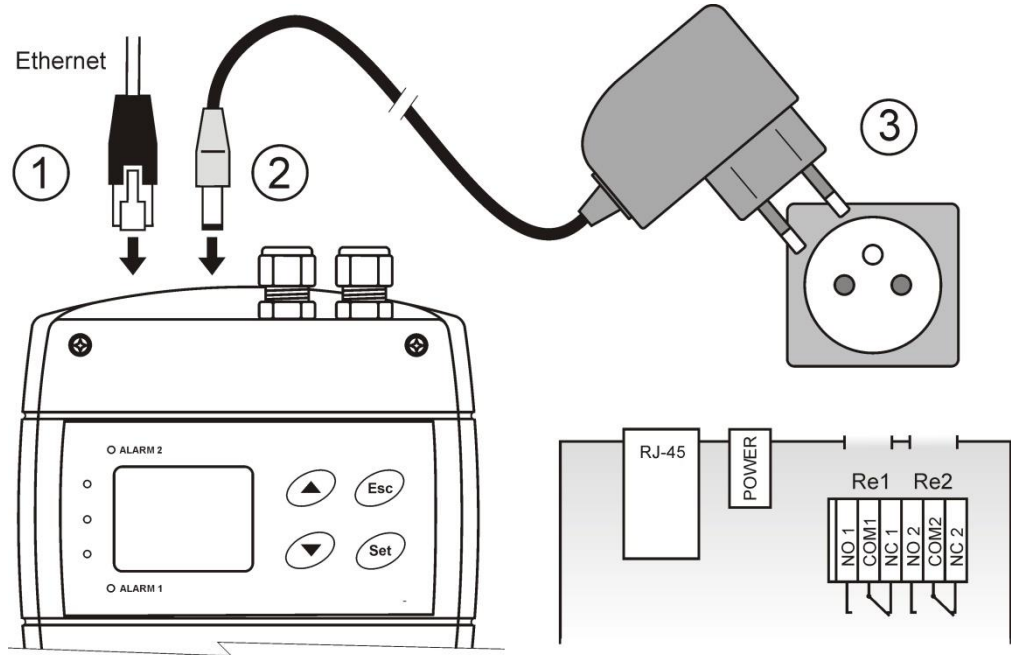

PoE splitter

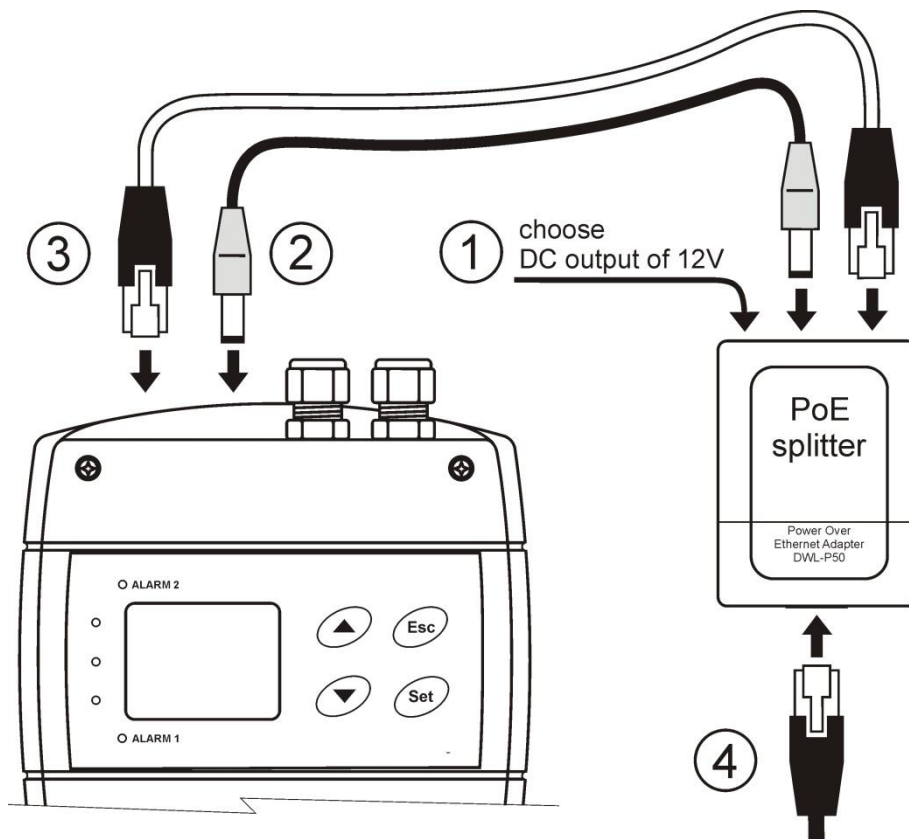

4. Dimensions

AT-VLS-101DE

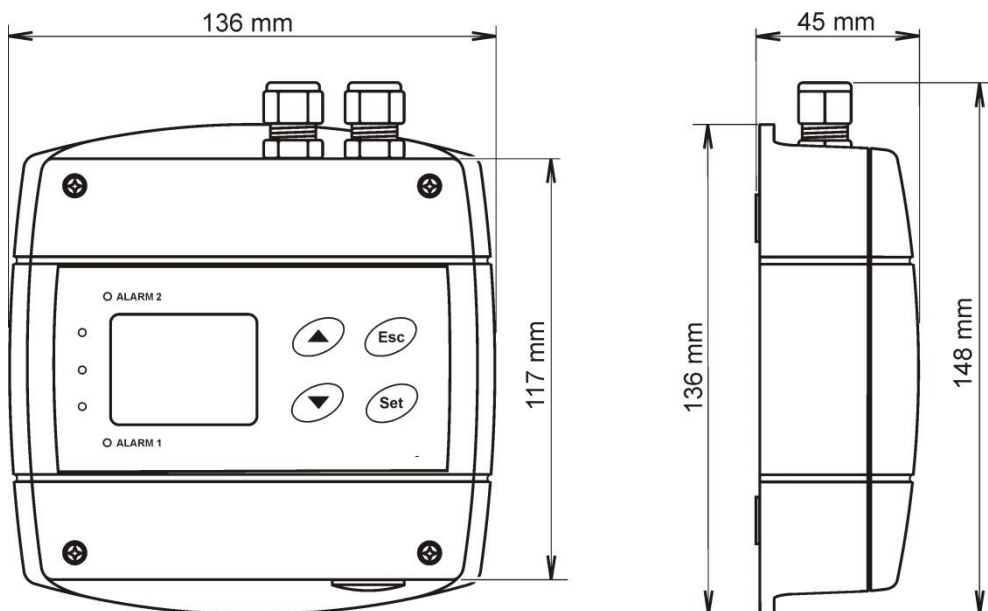

AT-VLS-102DE

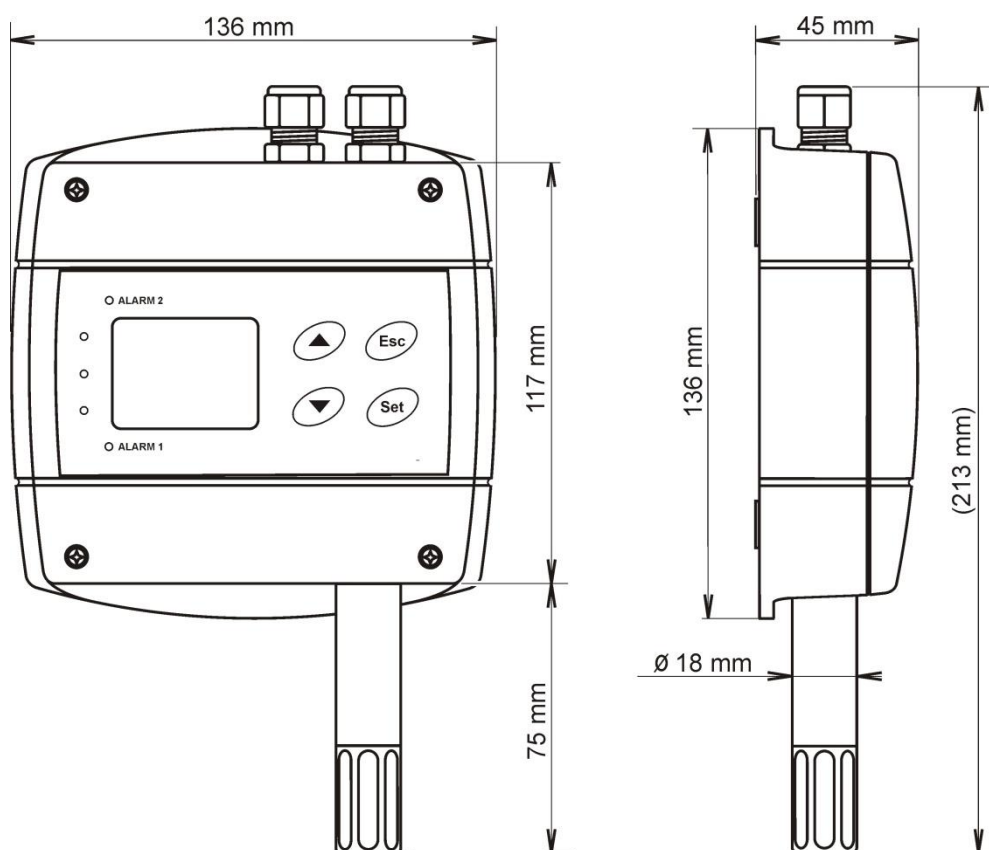

AT-VLS-104DE

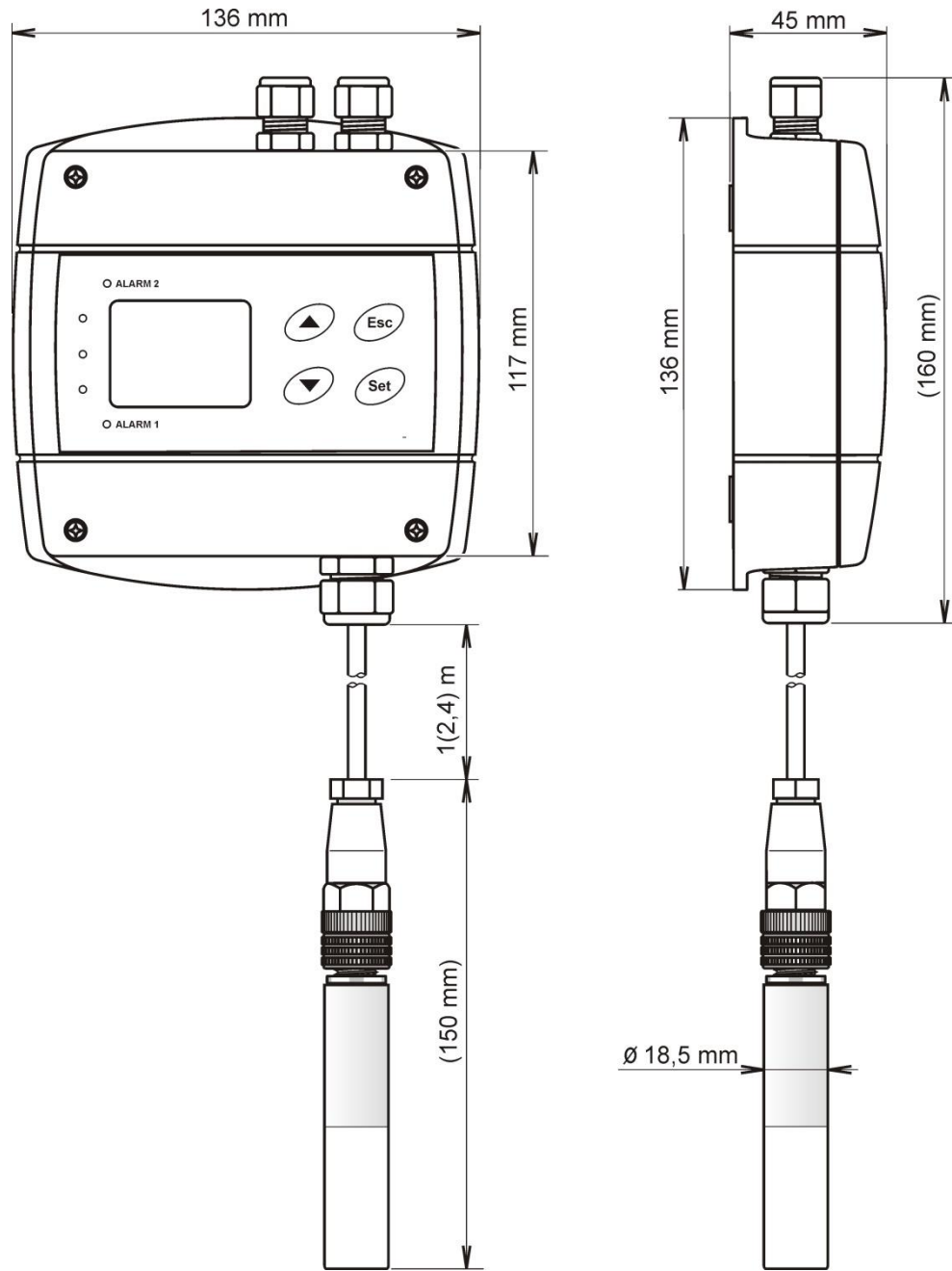

AT-VLS-106DE

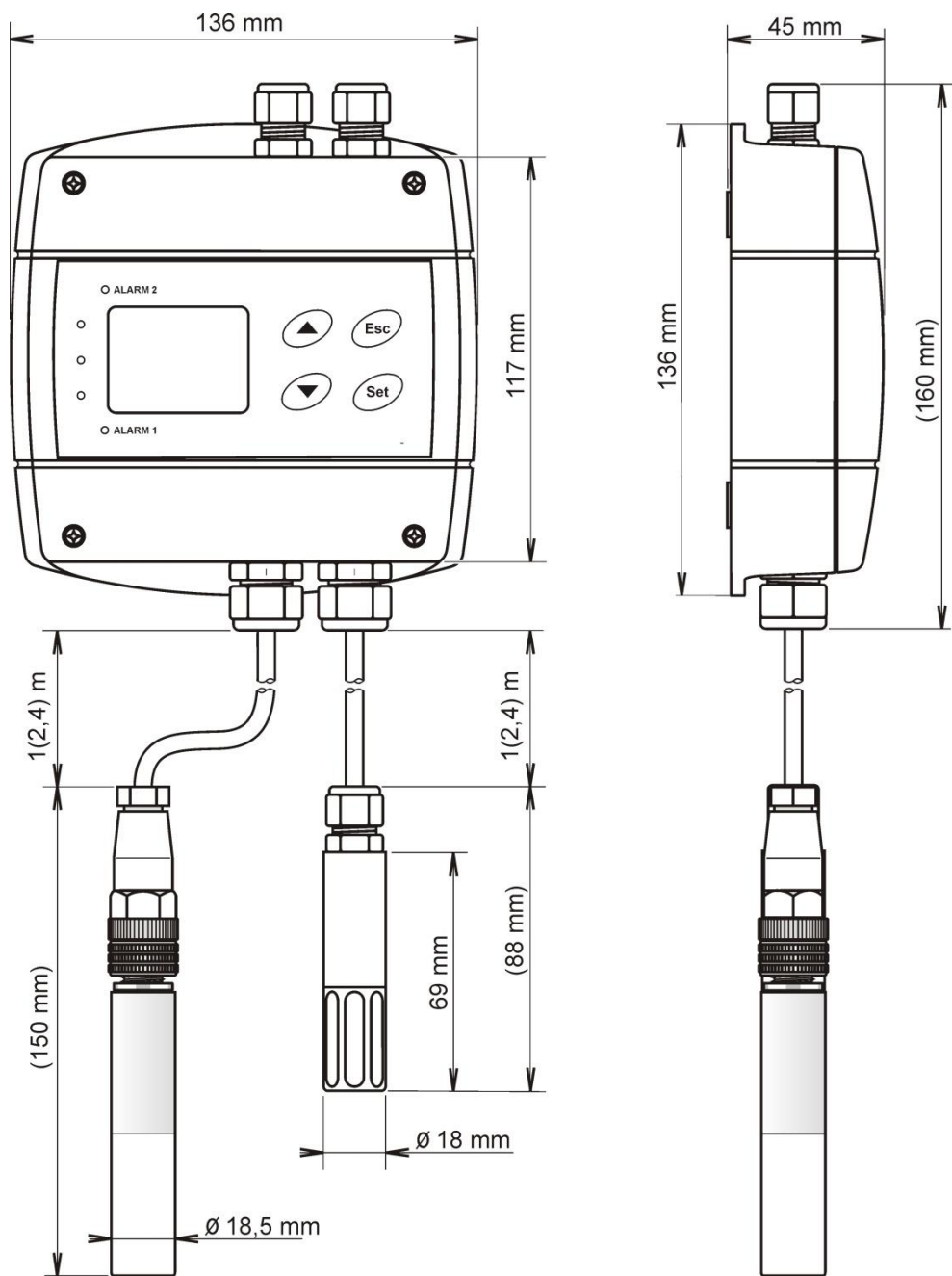

5. Installation

It is necessary to assign a new suitable IP address to the device at the first connection to it in order to prevent collisions with already existing network IP addresses, and make the address conform to the local habits. If installing several new devices, connect them to the network one after another! If a suitable IP address is not known, contact your network administrator and ask him for the following:

IP address of regulator	_____ . _____ . _____ . _____
IP address of gateway	_____ . _____ . _____ . _____
Network mask	_____ . _____ . _____ . _____

The IP gate address and the network mask need not be specified if the device will be operated only in a local network. If you set the IP address to one which is already used in the network the device will NOT work correctly and collisions in the network will appear. It is possible to set the IP address by DHCP server.

Device setting from the manufacturer:

IP address:	192.168.1.213
Gateway:	not set
Value assigned to Relay1 and Relay2:	none
Password for setting through keys (PASS):	0000
Password for setting via TSensor:	none
Value shown at first LCD line:	temperature / CO2 - by device type
Value shown at second LCD line:	relative humidity / dew point temp. - by device type
Temperature unit:	°C
Computed value preset:	dew point temperature
Relay response for error:	stay unchanged at previous condition
Acoustic alarm:	off
LED indication of CO ₂ concentration:	up to 1000 ppm lights green LED, between 1000 and 1200 ppm lights yellow LED and over 1200 ppm lights red LED
altitude:	300 m above sea level at the installation site

5.1. Installation procedure

- run TSensor software (default regulator IP address is 192.168.1.213) or use command line at PC with command „telnet 192.168.1.213 9999“. Telnet provides to set all Ethernet services. For setting of measurement and controlling of output relays use keys – see chapter “Regulator setting change – part of measurement unit” at page 13.
- assign new regulator IP address
- make your own regulator setting by your requirements (alarm settings, used units, email and trap sending ...) and save settings

6. Operation checking

6.1. Visual check

When power source is on, there are actually measured values shown on LCD (if the LCD has not been switched off). When Ethernet cable is connected, there is one light on its connector lighting.

6.2. Communication check via a LAN

Open a browser of WWW pages and enter the devices IP address into appropriate field.

Example: `http://192.168.1.213`

Regulator shows its name, serial number, measured values, alarm status and alarm settings or shows message `Access denied` in case of web pages are disabled or setting through Telnet is in operation.

7. Description of device function and setting

Information from regulator is available directly through LCD or you can read them with one of next communication protocols. For communication through some communication protocol (SNMPv1, Modbus, SOAP) there is necessary to have installed appropriate software supporting appropriate communication protocol on PC. Such software is not included in the delivery! The device is internally separated into two units. The first unit provides measurement and controlling of output relays – these parameters are possible to change directly through device's keys or TSensor software. The second unit provides all Ethernet services, its configuration is possible through Telnet terminal or TSensor software (this setting is impossible to change through device's keys).

7.1. Relay outputs

Regulator is equipped with two relay outputs. It is possible to assign any input or computed value or "far control" to each relay, to set comparing alarm limit, if the relay may close if measured value is higher (Hi) or lower (Lo) than preset limit, delay for while must be preset condition true before relay close its contact and hysteresis for return to open status. Each relay status is indicated with LED diode and shown on LCD with corresponding symbols „ALARM 1“ or „ALARM 2“.

The output relays of device are not able to switch power circuits or higher voltages. In such case we should use suitable type of power relays with coil in accordance to chapter "Common parameters". For wiring see Appendix A.

7.2. Carbon dioxide concentration measurement

Principle of CO₂ concentration measurement is based on Non-Dispersive Infrared Technology (NDIR). It is maintenance free because of the patented auto calibration feature, compensating for the effects of aging and therefore a guarantee for outstanding long-term stability. If the device is in operation permanently, an auto-adjustment will start automatically after 24 hours operation each. Measured values can be read in „SLOW mode“ (filtered, averaged) or in „FAST mode“ (current values without averaging). SLOW mode has advantages in applications like climate control because of filtering short time peaks. As an example exhaled air from an employee passing the sensor could affect the climate control negatively with a short response time because the control would trigger a change of the ventilation based on this one-time measurement. On the contrary in „FAST mode“ no software filter is used for calculating the output value. This fact adds a noise of typ. ± 30 ppm which has to be considered in terms of accuracy. Of principle measurement is the measured value of CO₂ concentration depends on the value of air pressure - altitude at the installation site. For this reason, it is suitable for accurate measurement to set the altitude of the installation site by TSensor software.

After power up there is internal check in progress and takes about 20 s. During this time LCD display shows (---) instead of CO₂ concentration value.

Parameter setting description is into chapter "Regulator setting change – part of measurement unit" at page 13.

7.3. Actual regulator preset – measurement part

It is NOT possible to make any changes of Ethernet services, for their setting see chapter “Regulator configuration – Ethernet interface” at page 19. If output relay alarm condition configuration is made using Modbus protocol, keyboard is blocked for this time. During this configuration is a word “bLoc” shown in the display.

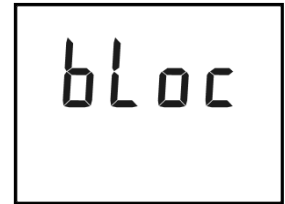

It is possible to display actual regulator preset on its LCD display by pressing of „▲“ key. LCD shows information about Relay1 and then Relay2 setting step by step. Information about Relay1 are indicated with symbol „ALARM 1“, for Relay2 with symbol „ALARM 2“ (at right top corner of LCD). It is possible to edit parameters after pressing „SET“ key and entering of correct password „PASS“ - see chapter “Change of “Password for setting through keys” (PASS)” at page 16. Following examples are for Relay1 setting, similarly are displayed values for Relay2. Pressing of „ESC“ key ends this mode and switch to actual value displaying, the same occur if more than 20 s is not pressed any key.

7.3.1. Value assigned to output relay

None, relay is still off



Temperature at °C



Relative humidity



Computed value – dew point temperature



CO₂ concentration

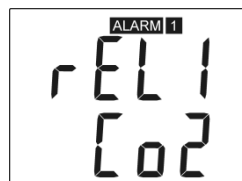

Far condition 0



Far condition 1



FAR0 – „far condition 0“: after device’s power on the relay is open
 FAR1 – „far condition 1“: after device’s power on the relay is close
 If “far condition” is assigned to output relay, then there is possible to change the output relay status by Modbus communication protocol only. See chapter “Modbus protocol” at page 20.

7.3.2. When close output relay

High limit „HI“ – the relay close when measured value exceeds preset „high limit” for longer time than preset „delay time“. Relay goes open when measured value decrease under „high limit” value minus the „hysteresis” value. See example.

High limit „HI“



Delay [s]

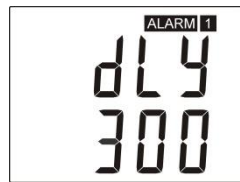

Hysteresis

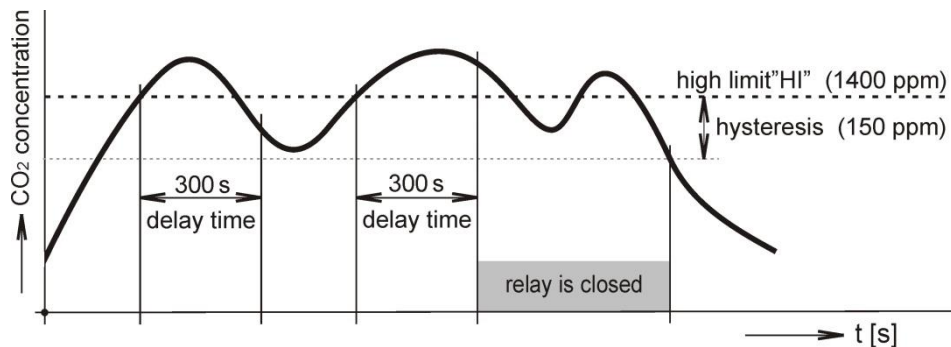

Low limit „Lo“ – the relay close when measured value falls below preset „low limit“ for longer time than preset „delay time“. Relay goes open when measured value exceeds „low limit“ value plus the „hysteresis“ value. See example.

Low limit „Lo“

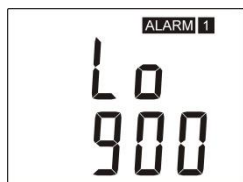

Delay [s]

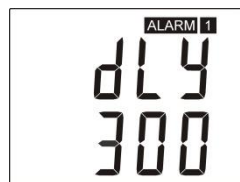

Hysteresis

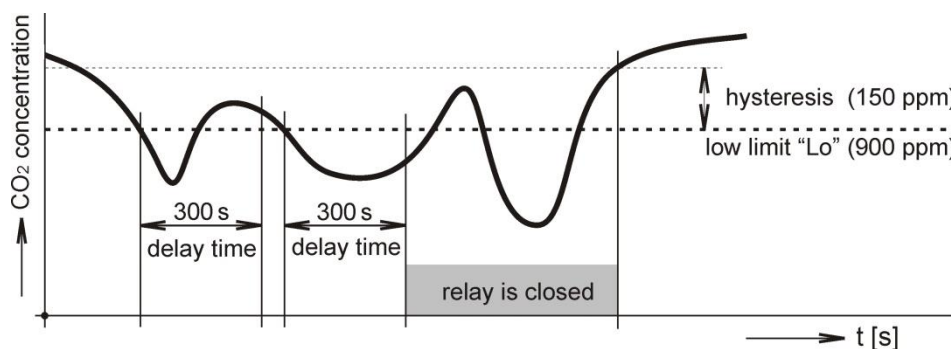
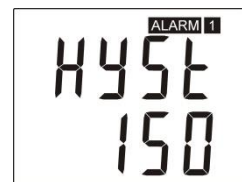

7.4. Regulator setting change – part of measurement unit

7.4.1. Setting with PC and TSensor software

User's software **TSensor** is available free to download at web page. It provides **setting of all regulator parameters**. Run the TSensor program and follow the program instructions. Regulator includes hardware write protection of internal setting (except of Ethernet setting which is protected by password), new setting is possible to write only while:

1. during write period press „SET“ key – do requested setting in TSensor software, press „SET“ key on regulator and keep it down, then click on the button „Save Changes“ into TSensor software and after end of write release „SET“ key, or
2. jumper placed nearby keys is closed (jumper is accessible after demounting of four screws in the corners of the box and removing the lid, don't confuse with jumper nearby Ethernet connector!). This jumper is suitable e.g. until device adjustment is in process and regulator is placed into calibration box and keys are not accessible. Don't forget to remove (open) jumper after procedure finish (restore write protection)

TSensor software supports to make the adjustment of the regulator too. This procedure is described at file „*Calibration manual.pdf*“ which is installed commonly with the software.

7.4.2. Setting with using regulator keys

If „Actual regulator preset“ is displayed, it is possible to enter into edit mode and edit displayed value by pressing „SET“ key. Then you are asked for valid password „PASS“. You can edit selected value if right password is entered. During value editing there is range check executed and edited value is still compared with limits for corresponding value (range). If inserted value is higher or lower then edited number is automatically changed to its maximum / minimum value – for possible range see chapter „Technical parameters“ at page 26. Value can be changed with using „▲“ and „▼“ keys. Edited value is switched in “round” -9, -8, -7, ...-2, -1, 0, 1, 2, ...8, 9. To edit next number digit press „SET“ key, for moving back to previous digit press „ESC“ key. Edited value is stored by next „SET“ key pressing. It is possible to cancel editing by pressing „ESC“ key if necessary. If valid password is once inserted right, then there is possible to edit next items without asking for password insertion again, till “Actual regulator preset” is left (till actual measured values are shown). With new entering into edit mode it is necessary to enter Password again. Default password setting is preset from manufacturer to 0000, password change is possible into „Extended setting“. During edit mode regulator still works and changes are valid immediately after its storing – it is not necessary to restart regulator.

7.4.3. Extended setting mode

During regulator operation it is possible to change parameters available through “Actual regulator preset” only (see chapter “*Actual regulator preset – measurement part*” at page 12). Rest of regulator parameters are available through “Extended setting mode”. **In this mode regulator does NOT communicate, does NOT do any measurements and does NOT service output relays. To leave this mode press „ESC“ key and open jumper nearby keys. To enter into extended setting mode do following steps:**

1. disconnect power supply
2. demount four screws in the corners of the box and remove the lid
3. closed jumper placed nearby keys (don't confuse with jumper nearby Ethernet connector)
4. press „▲“ and „▼“ keys together and keep them down
5. connect power supply to regulator – you should see message „SEL“ on the top line of LCD and on the bottom line you should see number of Firmware version (e.g. 0401)
6. release „▲“ and „▼“ keys – you are into “Extended setting mode” now

Use „▲“ and „▼“ keys to inspect each items. If you want to change some shown item then press „SET“ key, item starts blink. Now you can edit setting with using „▲“ and „▼“ keys. To store preset value press „SET“ key. Press „ESC“ key to leave editing (changing) without save – last stored value is kept.

Acoustic alarm assign to Relay1 (Relay2)

acoustic indication of Relay1 is OFF

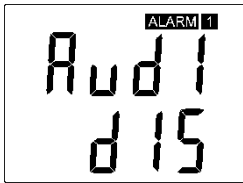

close of Relay1 contact starts acoustic indication

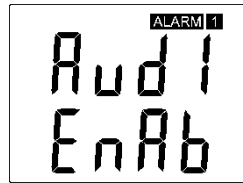

acoustic indication of Rela 2 is OFF

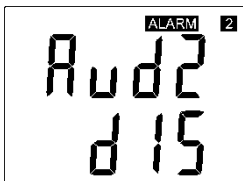

close of Relay2 contact starts acoustic indication

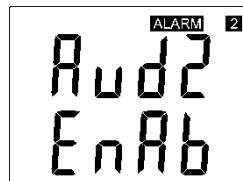

Acoustic alarm deactivation

activated acoustic alarm is possible to deactivate by pressing „ESC“ key



acoustic alarm is still activated for all time and it is impossible to deactivate it



Relay response for error

Regulator continuously checks its state during operation. In case error of assigned value measurement is found then output relay:

stays unchanged (in previous status)



Relay1 switch OFF



Relay1 switch On



stays unchanged (in previous status)



Relay2 switch OFF



Relay2 switch On



password setting

Change of "Password for setting through keys" (PASS)

This item shows actual password setting. It is possible to change it after „SET“ key pressing. It is number from range -19999 to +19999.

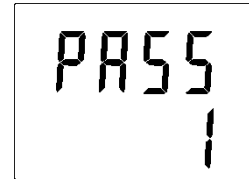

Temperature unit choice

It is possible to measure temperature at °C or °F. There is shown preset unit. It is possible to change it after „SET“ key pressing.

preset to °C

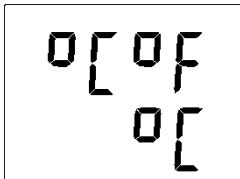

preset to °F

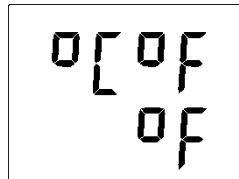

CO₂ measurement mode selection

This item provides to choice if measured value is displayed and read in "SLOW" or "FAST" mode. "FAST" mode provides last measured value without averaging; this means that no software filter is used for calculating the output value. "SLOW" mode provides value averaged from last 11 "FAST" measured values.

averaged value „SLOW“ mode



current value without averaging „FAST“ mode



CO₂ zone level indication setup

Whole measuring range can be divided into three areas. Each active area there is indicated by green, yellow or red LED depends on actual measured value. It is done by two boundary limits setting. „YELL“ limit sets boundary between green and yellow indication. It means that if actual measured value is lower than „YELL“ limit, there is green LED active. If actual measured value is higher than „YELL“ limit, then there is yellow LED active. Yellow LED lights until actual measured value exceeds „RED“ limit. If actual value is higher than „RED“ limit, red LED is active. If you don't want to use this indication then set "YELL" limit to 0.

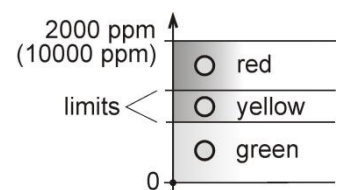

„YELLOW“ limit setting



„RED“ limit setting



Show temperature at LCD display

This item provides to choice if actual measured temperature may be displayed at LCD display or not. It is possible to change it after „SET“ key pressing.

show value on LCD

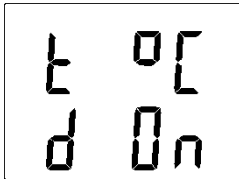

don't show value on LCD



Show relative humidity at LCD display

This item provides to choice if actual measured relative humidity may be displayed at LCD display or not. It is possible to change it after „SET“ key pressing.

show value on LCD

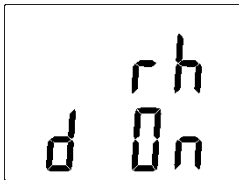

don't show value on LCD



Show computed value at LCD display

This item provides to choice if actual computed value may be displayed at LCD display or not. There is shown the name of computed value on the top LCD line. It is possible to change it after „SET“ key pressing.

show value on LCD

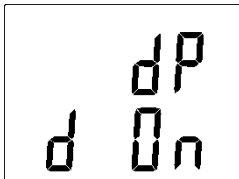

don't show value on LCD



Show CO₂ concentration at LCD display

This item provides to choice if CO₂ value may be displayed at LCD display or not. It is possible to change it after „SET“ key pressing.

show value on LCD



don't show value on LCD



Computed value selection

It shows the actually selected computed value name. It is possible to change it after „SET“ key pressing. There is possible choice one of the following computed values:

dew point temperature



absolute humidity



mixing ratio



specific humidity



specific enthalpy

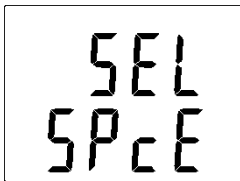

7.5. Restore to „Factory default“ – measurement part

This item provides regulator restoring to factory setting. Press „SET“ key, select „YES“ and confirm it by pressing of „SET“ key. It reset regulator parameters to following values:

Value assigned to Relay1 and Relay2:	none
Password for setting through keys (PASS):	0000
Display:	on
Temperature unit:	°C
Computed value preset:	dew point temperature
Relay response for error:	stay unchanged at previous condition
Acoustic alarm:	off

restore to factory default

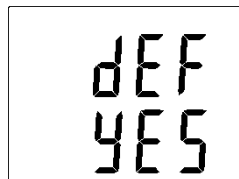
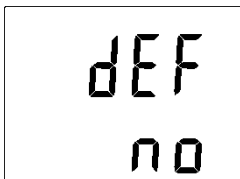

7.6. Regulator configuration – Ethernet interface

The Ethernet configuration is performed by `TSensor` software¹ or Telnet setup. Setting through the Telnet is described in separated document. Access to the Setup can be protected by a password. `TSensor` program you can find on web or on the installation CD. This program is free for use and supports firmware update. The newest firmware is available at web pages too.

7.7. Alarms – Ethernet interface

7.7.1. Analogue values

It is possible to set an upper limit, lower limit, hysteresis and time delay to each measured value. Figure shows a temperature curve with some specified upper limit (`temp_limit_high`) and hysteresis. At point 1 temperature exceeds the limit. From that moment a time delay is counted (`time_delay`) after which an alarm is set. Because at point 2 the temperature dropped below the limit value (`temp_limit_high`) before the time delay expired, alarm was not set.

At point 3 the temperature again exceeded the limit, and because it did not drop below the limit value (`temp_limit_high`) before the time delay ended, the alarm was set at point 4. At this moment the alarm e-mails and traps are sent, if they are enabled, and the alarm flag is set (the flag is set when the alarm is active and reset when inactive). The state of the flag can be found on the WWW pages or via Modbus or the information console. The alarm lasted to point 5, where the temperature dropped below the limit value given by the adjusted hysteresis (`hysteresis`). For other measured values the principle of alarm activity is analogical.

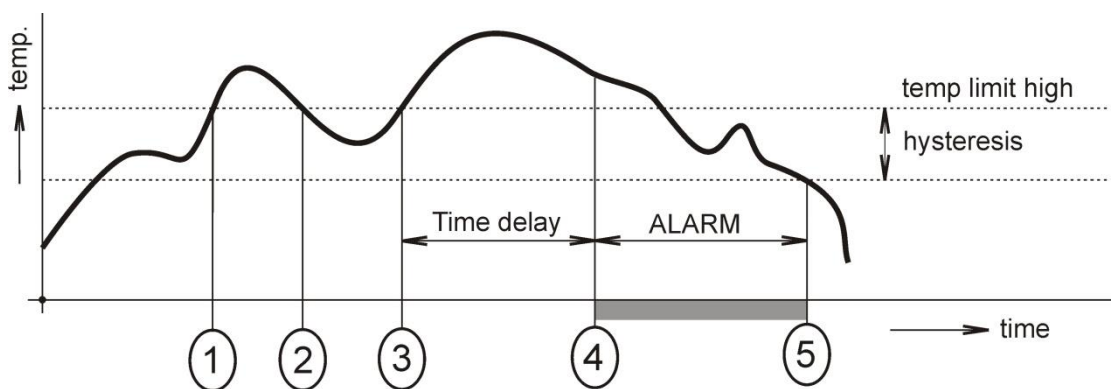

An alarm report is always sent right after an alarm appears. The device memorizes sent alarm reports of current alarms while the power is connected. In case of power disconnection or a reset of the device (e.g. by modification of configuration) a new alarm evaluation is performed and new alarm reports are sent again, if any.

It is possible to set the alarm parameters via telnet, Modbus protocol or a SNMPv1 protocol, `TSensor` program. Detailed description of setting via these protocols can be found in chapters informing about particular services.

¹ In telnet some settings are not allowed (display settings, computed value selection), see chapter 7.4

7.8. Factory default – Ethernet interface

This procedure describe how set Ethernet interface of device to factory defaults (new IP address: 192.168.1.212, mask: 255.255.255.0).

1. power off device
2. remove device cover
3. close jumper near the Ethernet interface
4. power on the device
5. wait approximately 15s
6. open jumper (remove shorting link)
7. close device cover

8. Communication protocols

8.1. Modbus protocol

The device contains support for the Modbus TCP protocol to communicate with control systems. The port is set to 502. Port 502 enables full access, i.e. both read and write operations are supported. Access to port can be disabled in the Setup. Maximal number of client transaction is set to 1.

Supported Modbus commands:

Command	Code	Description
Read multiple register(s)	0x03	Reads 16 bit register(s)
Write multiple register(s)	0x10	Writes 16 bit register(s)

Modbus registers of regulator:

Variable	Unit	Format	Address [hex]	Address [dec]	Status
measured temperature	°C, °F	Int*10	0x0031	49	r
measured relative humidity (RH)	%	Int*10	0x0032	50	r
computed value (CV)	CV depend	Int*10	0x0033	51	r
CO ₂ concentration displayed on LCD	ppm	Int	0x0034	52	r
device serial number Hi	-	BCD	0x1035	4149	r
device serial number Lo	-	BCD	0x1036	5150	r
Relay1 status [0/1]	-	Int	0x003B	59	r
Relay2 status [0/1]	-	Int	0x003C	60	r
far Relay1 control (see below) [0 – relay open, 1 – relay closed]	-	Int	0x0042	66	r/w
far Relay2 control (see below) [0 – relay open, 1 – relay closed]	-	Int	0x0043	67	r/w
CO ₂ concentration „FAST“ mode value	ppm	Int	0x0054	84	r
CO ₂ concentration „SLOW“ mode value	ppm	Int	0x0055	85	r
status word (described below)	-	Int	0x0007	7	r
firmware version Hi	-	BCD	0x3001	12289	r
firmware version Lo	-	BCD	0x3002	12290	r
lower limit for temperature	°C, °F	Int*10	0x5001	20481	r/w
upper limit for temperature	°C, °F	Int*10	0x5002	20482	r/w

Variable	Unit	Format	Address [hex]	Address [dec]	Status
lower limit for humidity	%	Int*10	0x5003	20483	r/w
upper limit for humidity	%	Int*10	0x5004	20484	r/w
lower limit for computed value	CV depend	Int*10	0x5005	20485	r/w
upper limit for computed value	CV depend	Int*10	0x5006	20486	r/w
temperature hysteresis	°C, °F	Int*10	0x5007	20487	r/w
temperature time delay	s	ulnt	0x5008	20488	r/w
RH hysteresis	%	Int*10	0x5009	20489	r/w
RH time delay	s	ulnt	0x500A	20490	r/w
computed value hysteresis	CV depend	Int*10	0x500B	20491	r/w
computed value time delay	s	ulnt	0x500C	20492	r/w
temperature alarm status	-	ASCII ^{a)}	0x500D	20493	r
RH alarm status	-	ASCII ^{a)}	0x500E	20494	r
computed value alarm status	-	ASCII ^{a)}	0x500F	20495	r
lower CO ₂ concentration limit	ppm	Int	0x5010	20496	r/w
upper CO ₂ concentration limit	ppm	Int	0x5011	20497	r/w
CO ₂ concentration hysteresis	ppm	Int	0x5012	20498	r/w
CO ₂ concentration limit status	-	ASCII ^{a)}	0x5013	20499	r
CO ₂ concentration time delay	s	ulnt	0x5014	20500	r/w
Relay1 alarm status	-	ASCII ^{b)}	0x5015	20501	r
Relay2 alarm status	-	ASCII ^{b)}	0x5016	20502	r

Legend:

- r register is designed for read
- w register is designed for write
- Int*10 register is in format of integer*10
- Int*X register is in format of integer*10, int*100, int*1000 depend on type
- BCD register is in format of BCD
- ulnt register is at range of 0-65535
- ASCII character, where:
 - a) Temperature, RH, computed value, pressure alarm status
 - no no alarm
 - lo value is bigger than specified upper limit
 - hi value is lower than specified lower limit
 - b) Relay alarm status:
 - op no alarm
 - cl relay is closed, alarm is signaled
- Status word: 16b value return, bite description:
 - Bit0 0/1 jumper open/closed
 - Bit3 0/1 Relay1 open/closed
 - Bit4 0/1 Relay2 open/closed
 - Bit5 0/1 internal acoustic alarm status
- Far relay control: open/close relay through Modbus protocol. Before using remote relay control option is necessary setup FAR0 or FAR1 to the relay.
 - FAR0 remote relay control, after device reboot relay is open
 - FAR1 remote relay control, after device reboot

Output relay alarm condition configuration:

8.2. SMTP

In case of exceeding adjusted limits of measured values the device can send e-mails to maximum of three addresses. It is necessary to set your SMTP server address (IP address, authentication, etc.) for correct function of e-mail sending.

If limits of several measured values are exceeded a special alarm e-mail is sent for each alarm state. Dummy address `sensor@[device IP address]` is displayed as a sender of the e-mail. It is not possible to reply to this address. In the Subject field of the message the sentence Alarm [Description of the device] is displayed or Test message [Description of the device] in the case of sending a test e-mail.

8.3. SNMPv1

By means of the SNMPv1 protocol it is possible to find currently measured values, read and set parameters concerning alarms. In case of alarm activation, warning message (a trap) can be sent to specified addresses. By means of the SNMPv1 protocol it is also possible to display history of last 100 measured values.

For read and write the device communicates via UDP port 161. Traps are sent via port UDP port 162. Sending of traps can be disabled in the Setup. **The following traps sent**

- 0/0 device restart
- 1/0 testing trap
- 1/1 SNTP time synchronization error
- 1/2 Ethernet firmware was uploaded
- 1/3 – 1/5 SOAP communication error
- 1/6 – 1/8 e-mail sending error
- 1/9 Configuration changed via SNMP or Modbus
- 6/3 – 6/55 report on a measured value being outside of the limits or a return of the measured value to the limits

For the correct function of the SNMPv1 server it is necessary to store the MIB table `Hx5xx.mib` and `RFC-1213.mib` to the MIB client. The path to the device is then:

```
iso.org.dod.internet.private.enterprises.comet.products.hx5xx
```

MIB tables are available on the installation CD in the MIB directory. Password for a read operation is set by the manufacturer to `public`, password for write is set to `private`. These passwords may be changed in the setup.

History

By means of the SNMPv1 protocol it is possible to display history of the last 100 measured values, stored in adjusted time interval. This interval is set by configuration program. If a value has not been measured yet or an error was detected the value is 9999, or -9999, if pressure is measured. The history is erased after each restart of the device. Restart occurred if device configuration is changed via keyboard or TSensor software.

8.4. WWW

The device supports display of measured values, adjusted limits and alarm states on its WWW pages. The address of the WWW pages is identical with its IP address. It is possible to upload self-made web pages to device.

Example: The device has an IP address 192.168.1.204. Enter `http://192.168.1.204` to the browser address field and confirm it with the Enter key.

WWW pages have adjustable automatic refresh interval. The manufacturer sets it to 60 seconds. The value can be modified in the setup in a range of 10–65535s. If the device has WWW pages display disabled screen with message `Access denied`.

8.5. SNTP

The device allows time synchronization with SNTP server. The time synchronization is set to every 8 hours. If the time synchronization failed in next three hours, SNTP trap, e-mail and Syslog message will be sent.

8.6. Syslog protocol

Device allows send messages to selected Syslog server (UDP protocol, port 514). Events are described below.

Event	Text
device restart	Device restart
test message	Testing message
alarm occurred	Alarm ...
SNTP connection error	NTP connection error
write to device via Modbus, SNMP	Settings changed
firmware was changed	Firmware uploaded
alarm is down	Clearing ...
SOAP server communication error	SOAP ...
e-mail sending error	EMAIL ...

8.7. SOAP

Device allows sending SOAP messages with measured values to user defined remote web server in preset time intervals 10-65535 s. If the device cannot establish connection with the web server in the whole delay interval, device sends trap 1/3 - 1/5.

How to configure sending SOAP messages example:

SOAP enable: Yes
Target web page: `my.hosting.nl/soap/server.php`
SOAP server IP address: `123.123.123.123`
Source port: 0 (never set to 80, causes it web server collision)
Destination port: 80 (http servers usually listens at this port)
Sending interval: 10

9. What to do when...

I forgot the IP address of the device

Finding the device IP address

IP address is set to the value 192.168.1.213 by the manufacturer. If you changed it and forgot the new IP address, run the TSensor program and press the "Find..." button. In a new window all sensors will be show.

It is not possible to connect to the device from a LAN

In the "Find device" window is only IP and MAC address displayed

The next information is displayed as N/A. This problem will be occurred, when the device IP is set to another LAN.

In TSensor program choose Find device/Change IP address. Follow the program instruction.

The sensor IP address in Find device window is not displayed

In TSensor program select Find device/Help my device Wasn't found! Follow the program instruction.

Finding the MAC address

The MAC address is a unique address of a device which is necessary to be known e.g. in case when there are several devices connected to the network. MAC address is on device label.

It is not possible to find meter after manual MAC enter

In TSensor program select Find device/Help my device Wasn't found. In this select Set IP to ARP only. Into device MAC address enter the meters MAC address (e.g. 00-20-4A-84-F0-80) and press the Set IP button.

Open telnet to the IP address you assigned to the device MAC address by running a telnet command `telnet [IP_address_assigned_to_MAC_address] 9999` and confirm with the Enter key.

Choose 0 - Global Settings, set the meters IP address, clear the gate IP, no. of net mask set to 0. Pres the Enter key, until you are not back into a menu. Press - 9 Save and Exit. The connection will be closed. Now you can connect to meter by the TSensor program.

LCD display is Off

- check if power supply is connected properly
- disconnect and connect the power supply - watch the display at the moment of connecting the power. If all LCD segments light for 1 second and go out again, the display is turned off by the software

10. Error States of the device

Device continuously checks its state during operation. In case error is found LCD displays corresponding error code:

Error 0 - first line of LCD displays „Err0“. Check sum error of stored setting inside device's memory. This error appears if incorrect writing procedure to device's memory occurred or if damage of calibration data appeared. At this state device does not measure and calculate values. It is a serious error, contact distributor of the device to fix.

Error 1 - measured or calculated value (except concentration of CO₂) is over upper limit of allowed full scale range. There is a reading „Err1“ on LCD display. Value read from the device is +999.9. This state appears in case of:

- Measured temperature is higher than approximately 600°C (i.e. high non-measurable resistance of temperature sensor, probably opened circuit).
- Relative humidity is higher than 100%, i.e. damaged humidity sensor, or humidity calculation of humidity is not possible (due to error during temperature measurement).
- Computed value – calculation of the value is not possible (error during measurement of temperature or relative humidity or value is over range).

The value of CO₂ concentration 9999 ppm is correct value!

Error 2 - there is a reading „Err2“ on LCD display. Measured or calculated value is below lower limit of allowed full scale range or CO₂ concentration measurement error occurred. Value read from the device is -999.9. This state appears in case of:

- Measured temperature is lower than approximately -210°C (i.e. low resistance of temperature sensor, probably short circuit).
- Relative humidity is lower than 0%, i.e. damaged sensor for measurement of relative humidity, or calculation of humidity is not possible (due to error during temperature measurement).
- Measured value of CO₂ concentration is outside the range 0 to 2000 (10000) ppm
- Computed value – calculation of computed value is not possible (error during measurement of temperature or relative humidity).

Error 3 - there is a reading „Err3“ on LCD display upper line. Error of internal A/D converter appeared (converter does not respond, probably damage of A/D converter). At this state device does not measure temperature and relative humidity and computed values are not calculated. This error does not affect CO₂ concentration measurement. It is a serious error, contact distributor of the device.

Error 4 - there is a reading „Err4“ on LCD display. It is internal device error during CO₂ concentration sensor initialization. Under this condition device does not measure concentration of CO₂. Value read from device is -9999 (concentration of CO₂). CO₂ sensor is probably damaged. It is a serious error, contact distributor of the device.

Error 5, 6 - there is problem with assigned value to output relay, there is some wrong setting (mismatch). This error appears if incorrect writing procedure to device's memory occurred.

Error 9 - inserted password is not valid, there is shown for short time message “Err9” on LCD display.

11. Readings on LCD display

°C, °F reading next to this symbol is measured temperature or error state of value

%RH reading next to this symbol is measured relative humidity or error state of value

CO2 ppm reading next to this symbol is measured concentration of CO₂ or error state of value. Blinking symbol „CO2 ppm“ on LCD indicates internal auto calibration of CO₂ sensor running. It runs automatically each 24 hours and takes about 90 s.

°C / °F DP reading next to this symbol is calculated dew point temperature or error state of value

g/m³ reading next to this symbol is calculated absolute humidity or error state of value

g/kg reading next to this symbol is calculated specific humidity or mixing ratio (depends on device setting) or error state of value

3 this symbol is on if jumper is closed

If specific enthalpy is selected, there is shown only value (number) without corresponding unit.

12. Preventive maintenance and calibration

Pay heed to recommended calibration interval. Do not subject the device to mechanical stress.

Recommended calibration intervals:

- AT-VLS-104DE 5 years (CO₂)
- AT-VLS-101DE 5 years (CO₂)
- AT-VLS-102DE 5 years (CO₂), 1 year (relative humidity), 2 years (temperature)
- AT-VLS-106DE 5 years (CO₂), 1 year (relative humidity), 2 years (temperature)

13. Technical specification

13.1. Technical parameters

13.1.1. Common parameters

Power voltage: 9 to 30 V DC

Power consumption: 1W during normal operation
4W for 50ms with 15 s period

Power connector: coaxial connector, diameter 5,5 x 2,1 mm, (+) internal contact

Measuring interval: temperature, relative humidity 2s
concentration of CO₂ 15s

Display switching interval: 4 s (when more than two values are displayed)

Communication with computer: Ethernet connection (RJ-45 connector)

Relay outputs: Amount: 2
Maximal voltage: 50 V
Maximal current: 2A
Maximal power: 60 VA
Relays contact is not designed for direct control of line voltage!
(relay contact parameters: max 220Vdc, 125Vac, 2A, 60 W, 62.5 VA)

EMC: EN 61326-1, EN 55011, EN55022

13.1.2. AT-VLS-104DE - CO₂ regulator

Concentration of CO₂:

Accuracy:: $\pm (100 \text{ ppm} + 5 \% \text{ of measuring value})$ at 25°C (77°F) and 1013 hPa
Range: 0 to 10 000 ppm
Temperature dependence: typ. 2 ppm CO₂ / °C in the range 0 to 50 °C (32 to 122°F)
Long term stability: typ. 20 ppm / year
Resolution: 1 ppm

Response time: t₉₀ < 195 s in „SLOW“ measurement mode
t₉₀ < 75 s in „FAST“ measurement mode

13.1.3. AT-VLS-101DE - CO₂ regulator

Concentration of CO₂:

Accuracy:: $\pm (50 \text{ ppm} + 2 \% \text{ of measuring value})$ at 25°C (77°F) and 1013 hPa
Range: 0 to 2 000 ppm
Temperature dependence: typ. 2 ppm CO₂ / °C in the range 0 to 50 °C (32 to 122°F)
Long term stability: typ. 20 ppm / year
Resolution: 1 ppm

Response time: t₉₀ < 195 s in „SLOW“ measurement mode
t₉₀ < 75 s in „FAST“ measurement mode

13.1.4. AT-VLS-102DE – temperature, relative humidity and CO₂ regulator

Temperature:

Accuracy: $\pm 0,4 \text{ °C} (\pm 0,7 \text{ °F})$
Range: -30 to +60 °C (-22 to 140 °F)
Resolution: 0,1 °C (0,2 °F)

Relative humidity:

Accuracy: $\pm 2,5 \% \text{RH}$ from 5 to 95 %RH at 23 °C (73,4 °F)
Range: 0 to 100 %RH, temperature compensated
Resolution: 0,1 %RH

Concentration of CO₂:

Accuracy:: $\pm (50 \text{ ppm} + 2 \% \text{ of measuring value})$ at 25°C (77°F) and 1013 hPa
Range: 0 to 2000 ppm
Temperature dependence: typ. 2 ppm CO₂ / °C in the range 0 to 50 °C (32 to 122°F)
Long term stability: typ. 20 ppm / year
Resolution: 1 ppm

Measuring temperature and humidity range is limited in accordance with the graph below

Response time measurement of temperature and relative humidity with stainless steel mesh sensor cover (F5200B) and bronze sensor cover (F0000 - selectable option), air flow approximately 1 m/s:
temperature: t₉₀ < 6 min (temperature step 20 °C (36 °F))
relative humidity: t₉₀ < 30 s (humidity step 65 %RH, constant temperature)

Response time measurement of CO₂ concentration:

t₉₀ < 195 s in „SLOW“ measurement mode
t₉₀ < 75 s in „FAST“ measurement mode

13.1.5. AT-VLS-106DE – temperature, relative humidity and CO₂ regulator

Temperature:

Accuracy: $\pm 0,4\text{ }^{\circ}\text{C}$ ($\pm 0,7\text{ }^{\circ}\text{F}$)
Range: $-30\text{ to }+105\text{ }^{\circ}\text{C}$ ($-22\text{ to }221\text{ }^{\circ}\text{F}$)
Resolution: $0,1\text{ }^{\circ}\text{C}$ ($0,2\text{ }^{\circ}\text{F}$)

Relative humidity:

Accuracy: $\pm 2,5\text{ \%RH}$ from 5 to 95 %RH at $23\text{ }^{\circ}\text{C}$ ($73,4\text{ }^{\circ}\text{F}$)
Range: 0 to 100 %RH, temperature compensated
Resolution: $0,1\text{ \%RH}$

Concentration of CO₂:

Accuracy: $\pm (100\text{ ppm} + 5\text{ \% of measuring value})$ at $25\text{ }^{\circ}\text{C}$ ($77\text{ }^{\circ}\text{F}$) and 1013 hPa
Range: 0 to 10000 ppm
Temperature dependence: typ. 2 ppm CO₂ / $^{\circ}\text{C}$ in the range 0 to $50\text{ }^{\circ}\text{C}$ ($32\text{ to }122\text{ }^{\circ}\text{F}$)
Long term stability: typ. 20 ppm / year
Resolution: 1 ppm

Measuring temperature and humidity range is limited in accordance with the graph below

Response time measurement of temperature and relative humidity with stainless steel mesh sensor cover (F5200B) and bronze sensor cover (F0000 - selectable option), air flow approximately 1 m/s:

temperature: $t_{90} < 6\text{ min}$ (temperature step $20\text{ }^{\circ}\text{C}$ ($36\text{ }^{\circ}\text{F}$))
relative humidity: $t_{90} < 30\text{ s}$ (humidity step 65 %RH, constant temperature)

Response time measurement of CO₂ concentration:

$t_{90} < 195\text{ s}$ in „SLOW“ measurement mode
 $t_{90} < 75\text{ s}$ in „FAST“ measurement mode

13.1.6. Relative humidity and temperature restriction

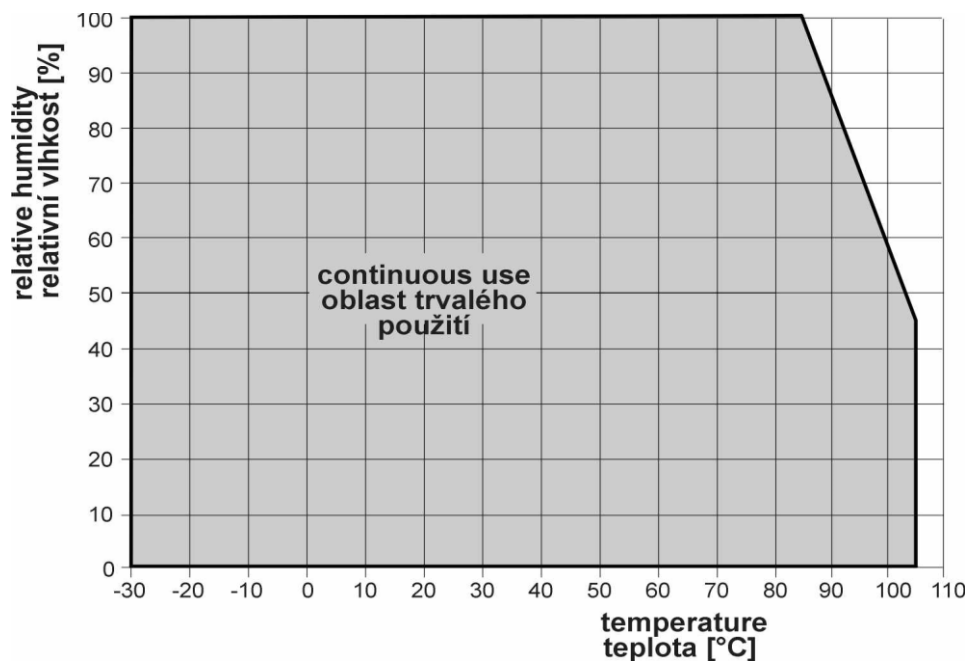

13.1.7. Value computed from measured relative humidity and temperature

Dew point temperature

Range: -60 to +80 °C (-76 to 176 °F)

Accuracy: $\pm 1,5^{\circ}\text{C}$ ($\pm 2,7^{\circ}\text{F}$) at ambient temperature $T < 25^{\circ}\text{C}$ (77°F) and relative humidity $\text{RH} > 30\%$, for more details see graphs below

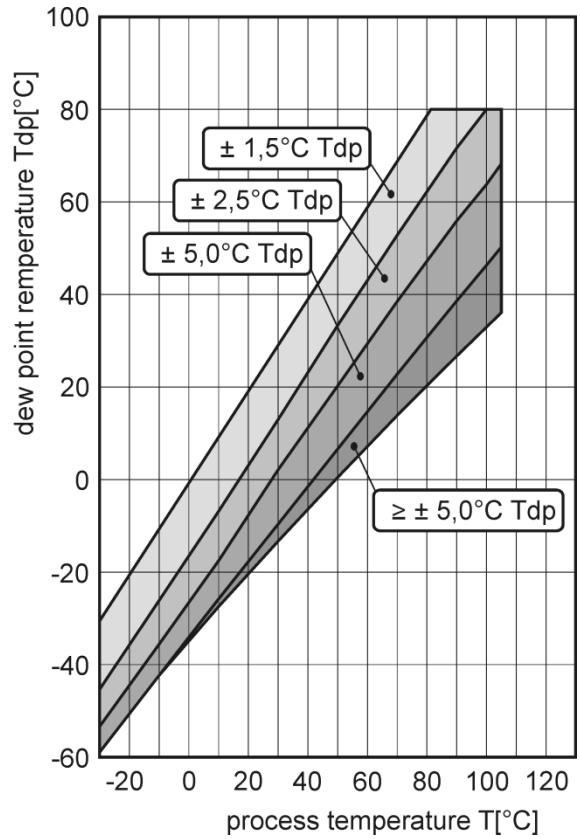
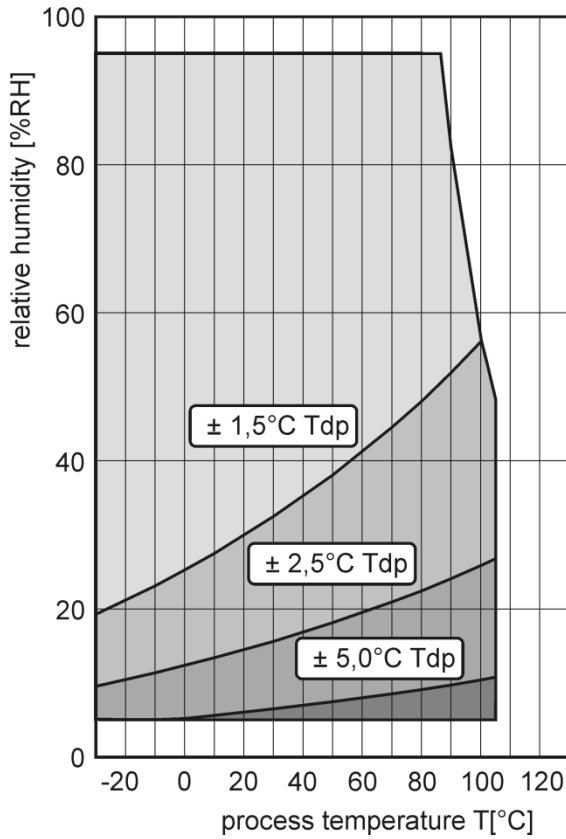

Absolute humidity

Range: 0 to 400 g/m³

Accuracy: $\pm 1,5 \text{ g/m}^3$ at ambient temperature $T < 25^{\circ}\text{C}$ (104°F), for more details see graph below

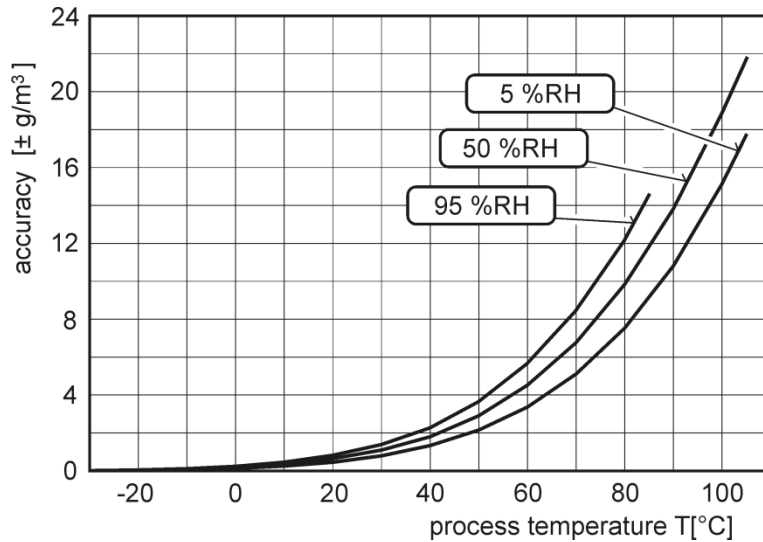

Specific humidity²

Accuracy: ±2g/kg at ambient temperature T < 35°C (95 °F)
Range: 0 to 550 g/kg

Mixing ratio²

Accuracy: ±2g/kg at ambient temperature T < 35°C (95 °F)
Range: 0 to 995 g/kg

Specific enthalpy²

Accuracy: ± 3kJ/kg at ambient temperature T < 25°C (77 °F)
Range: 0 to 995 kJ/kg³

The values computed from ambient temperature and relative humidity including their accuracy

13.2. Operating conditions

Operating temperature range:

electronics AT-VLS-104DE, AT-VLS-106DE:	-30 to +80 °C (-22 to 176 °F)
electronics AT-VLS-101DE, AT-VLS-102DE:	-30 to +60 °C (-22 to 140 °F)
measuring end of stem AT-VLS-102DE:	-30 to +80 °C (-22 to +176 °F)
CO₂ probe AT-VLS-104DE, AT-VLS-106DE	-40 to +60 °C (-40 to +140 °F)
RH+T probe AT-VLS-106DE:	-30 to +105 °C (-22 to +221 °F)

It is recommended to switch off the LCD display at ambient temperatures above 70°C around electronics.

Operating humidity range:

AT-VLS-104DE, AT-VLS-106DE: 0 to 100 % RH (no condensation)
AT-VLS-101DE, AT-VLS-102DE: 5 to 95 % RH (no condensation)

Operating barometric pressure range: 850 to 1100 hPa

Protection:

AT-VLS-104DE	IP30 (electronics), IP65 (CO ₂ probe)
AT-VLS-101DE	IP30 (electronics)
AT-VLS-102DE	IP30 (electronics), IP40 (measuring end of stem)
AT-VLS-106DE	IP30 (electronics), IP65 (CO ₂ probe), IP40 (RH+T probe)

Working position:

AT-VLS-104DE, AT-VLS-106DE: negligible
AT-VLS-101DE: with cable glands upwards
AT-VLS-102DE: with sensor cover downwards

Not allowed manipulations: It is not allowed to operate the device under conditions other than specified in technical parameters. Devices are not designed for locations with chemically aggressive environment. Temperature and humidity sensors must not be exposed to direct contact with water or other liquids. It is not allowed to remove the sensor cover to avoid any mechanical damage of the sensors.

² This value depends on the atmospheric pressure. For computing is used constant value stored in device memory. Default value preset by manufacturer is 1013hPa and can be changed by user's software.

³ This maximum is reached under conditions about 70°C/100%RH or 80°C/70%RH

Storage conditions:

temperature: -40 to +60 °C (-40 to 140 °F)
relative humidity: 5 to 95 % RH (no condensation)
atmospheric pressure: 700 a 1100 hPa

Dimensions: see dimensional drawings

Weight: approximately

AT-VLS-104DE/1m probe	420 g
AT-VLS-104DE/2m probe	450 g
AT-VLS-104DE/4m probe	510 g
AT-VLS-101DE	330 g
AT-VLS-102DE	350 g
AT-VLS-106DE/1m probe	500 g
AT-VLS-106DE/2m probe	570 g
AT-VLS-106DE/4m probe	710 g

Material of the case: ABS

13.3. End of operation

Device itself (after its life) is necessary to liquidate ecologically!

13.4. Technical support and service

The adjustment procedure is described at file „*Calibration manual.pdf*“ .

Technical support and service is provided by distributor. For contact see warranty certificate.

14. Appendix A

Connection of external power relay

Coil data chart of external power relay:

nominal voltage : max 50V
nominal power: max 60VA
current: max 2A

